

Micro Motion[®] F-Series Flow and Density Meters



High accuracy real world performance

- Best-in-class performance on liquid mass flow, volume flow, and density measurements in a compact design
- Rugged design minimizing process, mounting, and environmental effects

Best fit-for-application

- Cleanable, self-draining design for critical process control service
- Compact design enables installation flexibility
- Broad range of I/O offerings including HART, Profibus-DP, FOUNDATION[™] fieldbus, 4-20mA, and wireless capabilities

Exceptional reliability and safety

- No moving parts to wear or replace minimizes maintenance for long-term reliability
- 316L stainless steel and nickel alloy C22 wetted parts construction for compatibility with most fluids
- Robust sensor design

MICRO MOTION[™]



Micro Motion® F-Series flow and density meters

Micro Motion F-Series meters deliver superb measurement with exceptional flow and density performance as well as outstanding reliability for use in critical process control environments.

Tip

If you need help determining which Micro Motion products are right for your application, check out the [Micro Motion® Technical Overview and Specification Summary](#) and other resources available at www.emerson.com/flowmeasurement.

Optimal flow and density fit for critical process applications

- High performance rugged measurement in a compact drainable design that maximizes process up time
- Low frequency, high sensitivity fit-and-forget meter provides robust measurements even under demanding process conditions
- Multiple line sizes provide an ideal platform for batching, distribution, allocation and intra-plant measurement applications

Smart Meter Verification: advanced diagnostics for your entire system

- A comprehensive test that can be run locally or from the control room to provide confidence in your meter functionality and performance
- Verifies that your meter performs as well as the day it was installed, giving you assurance in less than 90 seconds
- Save significant expenditure by reducing labor and outsourced calibration service costs while eliminating process interruption

Industry-leading capabilities that unleash your process potential

- Available with the most extensive offering of transmitter and mounting options for maximum compatibility with your system
- State of the art, ISO/IEC 17025 compliant calibration stands achieving $\pm 0.014\%$ uncertainty drive best in class measurement accuracy
- The most comprehensive communication protocol offering in the industry including Smart Wireless
- True multi-variable technology measures necessary flow and density process variables simultaneously

Widest range of installation and process condition flexibility

- Featuring a low pressure drop, low weight design that reduces installation and commissioning costs
- Unmatched MVD transmitter technology with digital signal processing (DSP) delivers the fastest response rates enabling accurate batch and process measurement
- Design flexibility enables operation at high temperature (350 °C) or high pressure (430 barg) conditions to solve your toughest measurement challenges

Measurement principles

As a practical application of the Coriolis effect, the Coriolis mass flow meter operating principle involves inducing a vibration of the flow tube through which the fluid passes. The vibration, though it is not completely circular, provides the rotating reference frame which gives rise to the Coriolis effect. While specific methods vary according to the design of the flow meter, sensors monitor and analyze changes in frequency, phase shift, and amplitude of the vibrating flow tubes. The changes observed represent the mass flow rate and density of the fluid.

Mass flow measurement

The measuring tubes are forced to oscillate producing a sine wave. At zero flow, the two tubes vibrate in phase with each other. When flow is introduced, the Coriolis forces cause the tubes to twist resulting in a phase shift. The time difference between the waves is measured and is directly proportional to the mass flow rate.

Watch this video to learn more about how a Coriolis flow meter measures mass flow and density (click the link and select **View Videos**): <https://www.emerson.com/en-us/automation/measurement-instrumentation/flow-measurement/coriolis-flow-meters>.

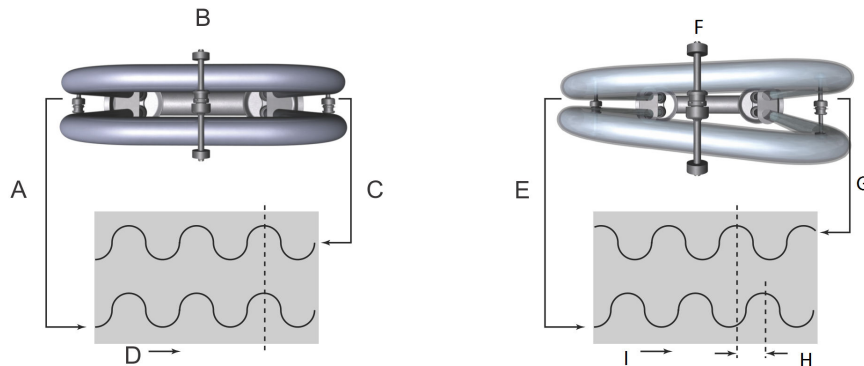

- A. Inlet pickoff displacement
- B. No flow
- C. Outlet pickoff displacement
- D. Time
- E. Inlet pickoff displacement
- F. With flow
- G. Outlet pickoff displacement
- H. Time difference
- I. Time

Density measurement

The measuring tubes are vibrated at their natural frequency. A change in the mass of the fluid contained inside the tubes causes a corresponding change to the tube natural frequency. The frequency change of the tube is used to calculate density.

Temperature measurement

Temperature is a measured variable that is available as an output. The temperature is also used internal to the sensor to compensate for temperature influences on Young’s Modulus of Elasticity.

Meter characteristics

- Measurement accuracy is a function of fluid mass flow rate independent of operating temperature, pressure, or composition. However, pressure drop through the sensor is dependent upon operating temperature, pressure, and fluid composition.
- Specifications and capabilities vary by model and certain models may have fewer available options. For detailed information regarding performance and capabilities, either contact customer service or refer to www.emerson.com/flowmeasurement.
- The letter at the end of the base model code (for example F100S) represents wetted part material and/or application designation: S = stainless steel, H = nickel alloy C22, P = high pressure, A = high temperature 316L stainless steel, B = high temperature nickel alloy C22. Detailed information about the complete product model codes are described later in this document.

Performance specifications

Reference operating conditions

For determining the performance capabilities of our meters, the following conditions were observed/utilized:

- Water at 68 °F (20.0 °C) to 77 °F (25.0 °C) and 14.5 psig (1 barg) to 29 psig (2 barg)
- Accuracy based on industry leading accredited calibration stands according to ISO/IEC 17025
- All models have a density range up to 3 g/cm³ (3,000 kg/m³)

Accuracy and repeatability

Accuracy and repeatability on liquids and slurries

Performance Specifications	Calibration code Z	Calibration code A ⁽¹⁾	Calibration code 1 ⁽¹⁾	Calibration code K ⁽²⁾	Calibration code C ⁽³⁾
Mass flow accuracy ⁽⁴⁾	±0.20% of rate	±0.15% of rate	±0.10% of rate	±0.10% of rate	±0.10% of rate
Volume flow accuracy ⁽⁴⁾⁽⁵⁾	±0.20% of rate	±0.15% of rate	±0.15% of rate	±0.10% of rate	±0.15% of rate
Mass flow repeatability	0.10% of rate	0.075% of rate	0.05% of rate	0.05% of rate	0.05% of rate
Volume flow repeatability	0.10% of rate	0.075% of rate	0.075% of rate	0.05% of rate	0.075% of rate
Density accuracy	±0.002 g/cm ³ (±2.0 kg/m ³)	±0.002 g/cm ³ (±2.0 kg/m ³)	±0.001 g/cm ³ (±1.0 kg/m ³)	±0.0005 g/cm ³ (±0.5 kg/m ³)	±0.002 g/cm ³ (±2.0 kg/m ³)
Density repeatability	0.001 g/cm ³ (1.0 kg/m ³)	0.001 g/cm ³ (1.0 kg/m ³)	0.0005 g/cm ³ (0.5 kg/m ³)	0.0002 g/cm ³ (0.2 kg/m ³)	0.001 g/cm ³ (1.0 kg/m ³)
Temperature accuracy	±1 °C ±0.5% of reading				
Temperature repeatability	0.2 °C				

(1) Not available with Model F100P; not available with electronics interface code J or U.

(2) Only available with electronics code 0, 1, 2, 3, 4, 5, 6, 7, 8, and 9; not available with Model F025 or any high temperature or high pressure models (base material/application code A, B, or P).

(3) Only available with Model F100P.

(4) Stated flow accuracy includes the combined effects of repeatability, linearity, and hysteresis.

(5) At calibration conditions and fluid.

Accuracy and repeatability on gases

Performance specification	All models
Mass flow accuracy ⁽¹⁾	±0.5% of rate
Mass flow repeatability ⁽¹⁾	0.25% of rate
Temperature accuracy	±1 °C 0.5% of reading
Temperature repeatability	0.2 °C

(1) Stated flow accuracy includes the combined effects of repeatability, linearity, and hysteresis

Liquid flow rates

Nominal flow rate

Micro Motion has adopted the term nominal flow rate, which is the flow rate at which water at reference conditions causes approximately 14.5 psig (1 barg) of pressure drop across the meter.

Mass flow rates for all models: 316L stainless steel (S/A), nickel alloy C22 (H/B), and high pressure (P)

Model	Nominal line size		Nominal flow rate		Maximum flow rate	
	inch	mm	lb/min	kg/h	lb/min	kg/h
F025	¼ in	DN6	50	1,366	100	2,720
F050P	½ in	DN15	84	2,287	168	4,570
F050S/H/A/B	½ in	DN15	155	4,226	300	8,160
F100P	1 in	DN25	400	11,000	800	22,000
F100S/H/A/B	1 in	DN25	717	19,510	1,200	32,650
F200	2 in	DN50	1,917	52,160	3,200	87,100
F300	3 in	DN80	4,900	133,356	8,744	238,499

Volume flow rates for all models: 316L stainless steel (S/A), nickel alloy C22 (H/B), and high pressure (P)

Model	Nominal flow rate			Maximum flow rate		
	gal/min	barrels/h	l/h	gal/min	barrels/h	l/h
F025	6	9	1,366	12	18	2,720
F050S/H/A/B	19	27	4,226	38	52	8,160
F050P	10	15	2,287	20	29	4,574
F100P	48	69	11,000	96	138	22,000
F100S/H/A/B	86	123	19,510	144	206	32,650
F200	230	328	52,160	384	550	87,100
F300	587	839	133,356	1,047	1,497	238,499

Gas flow rates

Gas flow rates

When selecting sensors for gas applications, pressure drop through the sensor is dependent upon operating temperature, pressure, and fluid composition. Therefore, when selecting a sensor for any particular gas application, it is highly recommended that each sensor be sized using the Online Store Sizing and Selection Tool at the Micro Motion web site (www.emerson.com/flowmeasurement).

The below table indicates mass flow rates that produce approximately 25 psig (1.72 barg) pressure drop on natural gas with molecular weight of 17 at 60 °F (15.6 °C) and 500 psig (34.47 barg).

Gas flow rates for all models: 316L stainless steel (S/A), nickel alloy C22 (H/B), and high pressure (P)

Model	Mass		Volume	
	lb/min	kg/h	SCFM	Nm ³ /h
F025	17	468	388	659
F050	52	1,429	1,183	2,010
F100P	125	3,400	2,888	4,909
F100S/H/A/B	200	5,452	4,514	7,670
F200	666	18,137	15,018	25,515
F300	1,745	47,505	39,334	66,829

Note

Standard (SCFM) reference conditions for natural gas with molecular weight of 17 are 14.7 psig (1.014 barg) and 60 °F (15.6 °C).

Zero stability

Zero stability is used when the flow rate approaches the low end of the flow range where the meter accuracy begins to deviate from the stated accuracy rating, as depicted in the turndown section. When operating at flow rates where meter accuracy begins to deviate from the stated accuracy rating, accuracy is governed by the formula: accuracy = (zero stability/flow rate) x 100%. Repeatability is similarly affected by low flow conditions.

Turndown capabilities

The graph and table below represent an example of the measurement characteristics under various flow conditions. At flow rates requiring large turndowns (greater than 20:1), the zero stability values may begin to govern capability dependent upon flow conditions and meter in use.

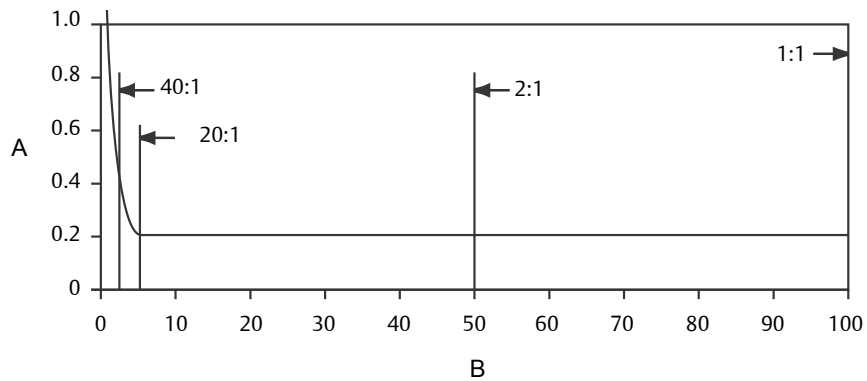

A. Accuracy, %
 B. Flow rate, % of nominal

Turndown from nominal flow rate	40:1	20:1	2:1	1:1
Accuracy	0.26	0.20	0.20	0.20
Pressure drop	0.0 psig (0.000 barg)	0.04 psig (0.0028 barg)	4.2 psig (0.290 barg)	14.5 psig (1.000 barg)

Zero stability for standard temperature/pressure models: 316L stainless steel (S), nickel alloy C22 (H)

Model	Zero stability	
	lb/min	kg/h
F025S/H	0.002	0.054
F050S/H	0.012	0.327
F100S/H	0.05	1.36
F200S/H	0.16	4.35
F300S/H	0.33	9.0

Zero stability for high temperature (A/B) and high pressure models (P)

Model	Zero stability	
	lb/min	kg/h
F025A/B/P	0.0065	0.177
F050A/B/P	0.02	0.544
F100A/B/P	0.08	2.18

Process pressure ratings

Sensor maximum working pressure reflects the highest possible pressure rating for a given sensor. Process connection type and environmental and process fluid temperatures may reduce the maximum rating. Refer to the Technical Data Sheet for common sensor and fitting combinations.

All sensors comply with Council Directive 2014/68/EU on pressure equipment.

Note

F-Series sensors with JIS process connections do not comply with ASME B31.1 power piping code.

Sensor maximum working pressure for all models: 316L stainless steel (S/A), nickel alloy C22 (H/B), and high pressure (P)

Model ⁽¹⁾	Pressure
F025S/A, F050S/A, F100S/A, F200S, F300S	1,450 psig (100 barg)
F025H/B, F050H/B, F100H/B, F200H, F300H	2,160 psig (149 barg)
F025P	2,320 psig (160 barg)
F050P	5,800 psig (400 barg)
F100P	6,250 psig (431 barg)

(1) Higher pressure ratings may be available. Contact factory for further information.

Case pressure

Case pressure for all models: 316L stainless steel (S/A), nickel alloy C22 (H/B), and high pressure (P)

Model	Case maximum pressure ⁽¹⁾	Typical burst pressure
F025	471 psig (32 barg)	1,884 psig (130 barg)
F050	383 psig (26 barg)	1,530 psig (105 barg)
F100	320 psig (22 barg)	1,281 psig (88 barg)
F200	190 psig (13 barg)	760 psig (52 barg)
F300	417 psig (29 barg)	1,668 psig (115 barg)

(1) Case maximum pressure is determined by applying a safety factor of 4 to typical burst pressure.

Operating conditions: Environmental

Vibration limits

Meets IEC 60068-2-6, endurance sweep, 5 to 2000 Hz, 50 sweep cycles at 1.0 g.

Temperature limits

Sensors can be used in the process and ambient temperature ranges shown in the temperature limit graphs. For the purposes of selecting electronics options, temperature limit graphs should be used only as a general guide. If your process conditions are close to the gray area, consult with your Micro Motion representative.

Note

- In all cases, the electronics cannot be operated where the ambient temperature is below -40 °F (-40.0 °C) or above 140 °F (60.0 °C). If a sensor is to be used where the ambient temperature is outside of the range permissible for the electronics, the electronics must be remotely located where the ambient temperature is within the permissible range, as indicated by the shaded areas of the temperature limit graphs.
- Temperature limits may be further restricted by hazardous area approvals. Refer to the hazardous area approvals documentation shipped with the sensor or available from the Micro Motion web site (www.emerson.com/flowmeasurement).
- The extended-mount electronics option allows the sensor case to be insulated without covering the transmitter, core processor, or junction box, but does not affect temperature ratings. When insulating the sensor case at elevated process temperatures (above 140 °F (60.0 °C)), please ensure electronics are not enclosed in insulation as this may lead to electronics failure.

Ambient and process temperature limits for standard-temperature models: 316L stainless steel (S), nickel alloy C22 (H), and high pressure (P)

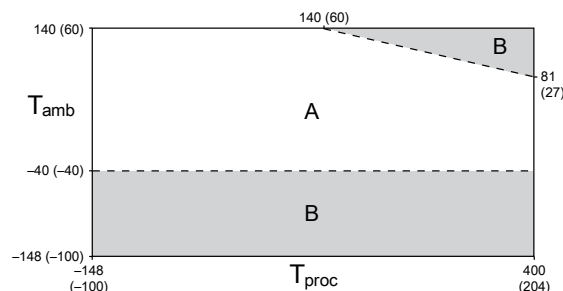

- T_{amb} = Ambient temperature °F (°C)
- T_{proc} = Process temperature °F (°C)
- A = All available electronic options
- B = Remote mount electronics only

Ambient and process temperature limits for high-temperature models: 316L stainless steel (A), nickel alloy C22 (B)

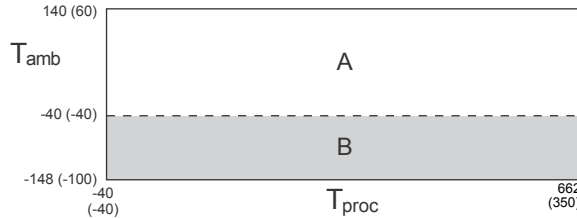

- T_{amb} = Ambient temperature °F (°C)
- T_{proc} = Process temperature °F (°C)
- A = All available electronic options
- B = Remote mount electronics only

Operating conditions: Process

Process temperature effect

- For mass flow measurement, process temperature effect is defined as the change in sensor flow accuracy due to process temperature change away from the calibration temperature. Temperature effect can be corrected by zeroing at the process conditions.
- For density measurement, process temperature effect is defined as the change in sensor density accuracy due to process temperature change away from the calibration density. See installation manual for proper setup and configuration.

Process temperature effect for all models: 316L stainless steel (S/A), nickel alloy C22 (H/B), and high pressure (P)

Model code	Mass flow rate (% of maximum rate) per °C	Density	
		g/cm ³ per °C	kg/m ³ per °C
F025, F050, F100, F200, F300	±0.0007	±0.0001	±0.1

Process pressure effect

Process pressure effect

Process pressure effect is defined as the change in sensor flow and density accuracy due to process pressure change away from the calibration pressure. This effect can be corrected by dynamic pressure input or a fixed meter factor. See installation manual for proper setup and configuration.

Process pressure effect for all models: 316L stainless steel (S/A), nickel alloy C22 (H/B), and high pressure (P)

Model code	Liquid or gas flow (% of rate) per psig (barg)	Density (g/cm ³) per psig (barg)
F025, F050, F100	none	none

Model code	Liquid or gas flow (% of rate) per psig (barg)	Density (g/cm ³) per psig (barg)
F200	-0.001 per psig (-0.015 per barg)	-0.00003 g/cm ³ per psig (-0.43 kg/m ³ per barg)
F300	-0.001 per psig (-0.015 per barg)	-0.00001 g/cm ³ per psig (-0.145 kg/m ³ per barg)

Pressure relief

F-Series sensors, except high-temperature (base model codes A and B), are available with a rupture disk installed on the case. Rupture disks are meant to vent process fluid from the sensor case in the unlikely event of a flow tube breach. Some users connect a pipeline to the rupture disk to help contain escaping process fluid. For more information about rupture disks, contact Micro Motion Customer Service.

If the sensor has a rupture disk, it should remain installed at all times as it would otherwise be necessary to re-purge the case. If the rupture disk is activated by a tube breach, the seal in the rupture disk will be broken, and the Coriolis meter should be removed from service.

The rupture disk is located as follows on the meter, and the warning sticker shown is placed next to it.

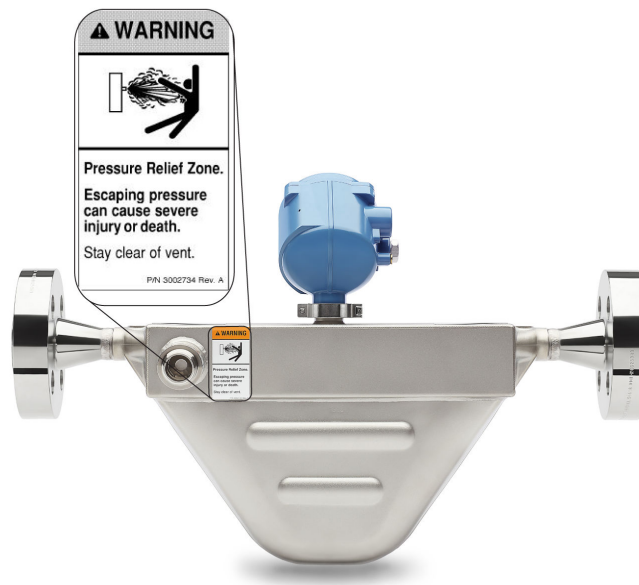

DANGER

Stay clear of the rupture disk pressure relief area. High-pressure fluid escaping from the sensor can cause severe injury or death.

The sensor must be oriented so that personnel and equipment will not be exposed to any discharge along the pressure relief path.

Important



If a rupture disk is used, the housing can no longer assume a secondary containment function.

WARNING

Removing the Purge Fitting, Blind Plug, or Rupture Disks compromises the Ex-i Safety Certification, the Ex-tc Safety Certification, and the IP-rating of the Coriolis meter. Any modification to the Purge Fitting, Blind Plug, or Rupture Disks must maintain a minimum of IP66/IP67 Ratings.

Hazardous area classifications

Approvals and certifications

Type	Approval or certification (typical)
CSA and CSA C-US	Ambient temperature: Ambient temperature: -40 °F (-40.0 °C) to 140 °F (60.0 °C) Class I, Div. 1, Groups C and D Class I, Div. 2, Groups A, B, C, and D Class II, Div. 1, Groups E, F, and G
ATEX	 II 1(2) G Ex ib IIB/IIC T6.T1 Ga/Gb II 2 D Ex ib IIIC T* °C Db IP66/IP67
	 II 3G Ex nA IIC T1-T4/T5 Gc II 3D Ex tc IIIC T* °C Dc IP66
IECEX	Ex ib IIB/IIC T1-T4/T5/T6 Ga/Gb Ex ib IIIC T* °C Db Ex nA IIC T1-T4/T5 Gc Ex tc IIIC T* °C Dc
NEPSI	Ex ib IIB/IIC T1-T6 Gb Ex ibD 21 T450°C-T85°C Ex nA IIC T1-T6 Gc DIP A22 T* T1-T6
Ingress Protection Rating	IP 66 for sensors; IP 66/67 for transmitters
EMC effects	Complies with EMC directive 2004/108/EC per EN 61326 Industrial
	Complies with NAMUR NE-21 (09.05.2012)

Note

- Approvals shown are for F-Series meters. Meters with integral electronics may have more restrictive approvals. Refer to the Product Data Sheet for each transmitter for details.
- When a meter is ordered with hazardous area approvals, detailed information is shipped along with the product.
- You can find more information about hazardous approvals, including detailed specifications and temperature graphs for all meter configurations on the F-Series product page at the Micro Motion web site (www.emerson.com/flowmeasurement).

Industry standards

Type	Standard
Weights and Measures for custody transfer applications	<ul style="list-style-type: none"> ■ MID OIML R117 ■ National Type Evaluation Program (NTEP) ■ Measurement Canada ■ INMETRO Brazil

Type	Standard
Industry standards and commercial approvals	<ul style="list-style-type: none"> ■ NAMUR: NE132 (burst pressure, sensor flange to flange length), NE131 ■ Pressure Equipment Directive (PED) ■ Canadian Registration Number (CRN) ■ Dual Seal ■ ASME B31.1 power piping code and ASME B31.3 process piping code ■ SIL2 and SIL3 safety certifications

Note

Some models do not meet all of the listed standards. Contact a sales representative for more information.

Marine approval classifications

For models F025S, F050S, F100S/P, F200S and F300S.

Marine approval	Country
Lloyd’s Register ENV1, ENV2, ENV3, ENV5	United Kingdom
Det Norske Veritas- Germanischer Lloyd	Norway-Germany
Bureau Veritas	France
American Bureau of Shipping	USA
Nippon Kaiji Kyokai	Japan

Transmitter interface

F-Series meters are highly customizable to provide a configuration that is tailor-fit to specific applications.

Robust transmitter offerings allow a multitude of mounting options:

- Compact mounting integral to the sensor
- Field mount variants for harsh conditions
- Compact control room DIN rail packages for optimal locating in a control cabinet
- Specific fit-for-purpose solutions for two-wire connectivity or filling and dosing machinery integration

F-Series meters are available with an expansive selection of input and output connectivity options including the following:

- 4-20 mA
- HART™
- WirelessHART™
- DeviceNet
- EtherNet/IP
- Profinet
- FOUNDATION™ fieldbus
- PROFIBUS
- Modbus®
- Other protocols may be available on request

Physical specifications

Materials of construction

General corrosion guidelines do not account for cyclical stress, and therefore should not be relied upon when choosing a wetted material for your Micro Motion meter.

Please refer to the *Micro Motion Corrosion Guide* from the www.emerson.com site for material compatibility information.

Wetted path materials

Model	Material options			Sensor weight	
	316L Stainless steel	Nickel alloy C22	Nickel alloy C22 and Stainless steel	lb	kg
F025	F025S/A	F025H/B	F025P	10	5
F050	F050S/A	F050H/B	F050P	11	5
F100	F100S/A	F100H/B/P		21	10
F200	F200S	F200H		42	20
F300	F300S	F300H		105	48

Note

- Weight specifications are based upon ASME B16.5 CL150 flange and do not include electronics.
- Heat jackets and steam kits are also available.

Non-wetted part materials

Component	Enclosure rating	316L stainless steel	304L stainless steel	Polyurethane-painted aluminum
Sensor housing	NEMA 4X (IP66)		•	
Core processor housing	NEMA 4X (IP66/67)	•		•
Junction box housing	NEMA 4X (IP66/67)	•		•
Model 1700/2700 transmitter housing	NEMA 4X (IP66/67/69K)	•		•
Model 3700 transmitter housing	NEMA 4X (IP66/67)			•
Model 2400S transmitter housing	NEMA 4X (IP66/67/69K) ⁽¹⁾	•		•
Model 2200S transmitter housing	NEMA 4X (IP66/67)	•		•
Model 5700 transmitter housing	NEMA 4X (IP66/67/69K)	•		•

(1) Stainless steel version.

Flanges

Sensor type	Flange types
Stainless steel 316L	<ul style="list-style-type: none"> ■ ASME B16.5 weld neck flange raised face (up to CL600) ■ EN 1092-1 weld neck flange form B1, B2, D (up to PN100), and F ■ JIS B2220 weld neck raised face (up to 40K) ■ NAMUR NE 132 compliant flange options for standardized face-to-face dimensions ■ VCO, VCR swagelok compatible fitting ■ Hygienic tri-clamp compatible
Nickel alloy C22	<ul style="list-style-type: none"> ■ ASME B16.5 lap joint flange (up to CL900/1500) ■ EN 1092-1 lap joint flange form B1 (up to PN40) ■ JIS B2220 lap joint flange (up to 10K) ■ Hygienic tri-clamp compatible
High pressure	<ul style="list-style-type: none"> ■ ASME B16.5 weld neck flange (up to CL2500) ■ VCO swagelok compatible fitting ■ EN 1092-1 weld neck flange type B2, D (up to PN160)

Note

- For flange compatibility, please refer to the Online Store Sizing and Selection Tool at the Micro Motion web site (www.emerson.com/flowmeasurement).
- Consult Micro Motion F-Series Technical Data Sheet for more information on available NAMUR NE 132 compliant flange options.

Dimensions

These dimensional drawings are intended to provide a basic guideline for sizing and planning.

Face-to-Face (Dim. A, below) dimensions for all F-series meters with each available process connection can be found in the F-series Technical Data Sheet.

Complete and detailed dimensional drawings can be found through the product link in our online store (www.emerson.com/flowmeasurement).

Note

- All dimensions $\pm 1/8$ inch (± 3 mm).
- Representative of a sensor model fitted with ASME B16.5 CL150 flange, and 2400 transmitter

Example dimensions for all models: 316L stainless steel (S/A), nickel alloy C22 (H/B), and high pressure (P)

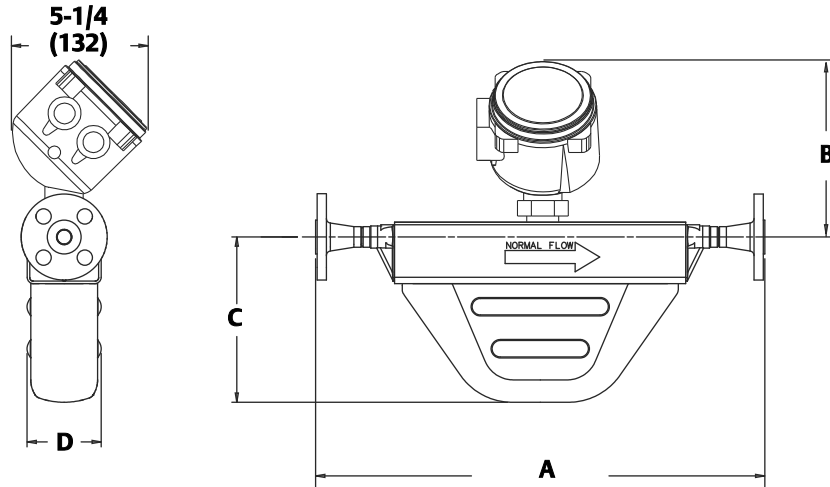

Model	Dim. A		Dim. B		Dim. C		Dim. D	
	Inch	mm	Inch	mm	Inch	mm	Inch	mm
F025	16	406	6-15/16	177	5-1/8	130	2-13/16	71
F050	18-1/8	460	6-15/16	177	6-3/4	171	2-15/16	75
F100	22-5/8	576	7-1/8	182	9-1/8	232	4-1/8	105
F200	24-3/4	629	8-1/8	206	12-9/16	319	5-5/8	143
F300	34-11/16	881	9-7/8	250	11-1/8	283	7-5/16	186

Ordering information

Model code structure

A complete sensor model code includes the ordering options.

Example code	Description
F	Sensor series
025	Model
S	Base model
113	Process connections
E	Case options
0	Electronics interface
B	Conduit connections
2	Approvals
E	Languages
Z	Additional standard approvals

Example code	Description
Z	Calibration
Z	Measurement application software (all models)
Z	Factory options

Base model

Code descriptions

Codes B, A, P, H, and S are model designations used to identify the type of meter.

Model	Material
B	High temperature nickel alloy C22
A	High temperature 316L stainless steel
P	High pressure
H	Nickel alloy C22
S	316L stainless steel

Codes available by model

Model	Available codes				
	S	H	P	A	B
F025 1/4-inch (6 mm)	S	H	P	A	B
F050 1/2-inch (13 mm)	S	H	P	A	B
F100 1-inch (25 mm)	S	H	P	A	B
F200 2-inch (50 mm)	S	H			
F300 3-inch (80 mm)	S	H			

Process connections

Model F025S

Code	Description					
113	1/2-inch	CL150	ASME B16.5	F316/F316L	Weld neck flange	Raised face
114	1/2-inch	CL300	ASME B16.5	F316/F316L	Weld neck flange	Raised face
115	1/2-inch	CL600	ASME B16.5	F316/F316L	Weld neck flange	Raised face
116	DN15	PN40	DIN 2635	F316/F316L	Weld neck flange	Form C face
120	DN15	PN100/160	DIN 2638	F316/F316L	Weld neck flange	Form E face
121	1/2-inch		Tri-Clamp compatible	316L	Hygienic fitting	
122	15mm	20K	JIS B 2220	F316/316L	Weld neck flange	Raised face

Code	Description					
150	1/2-inch	CL900/1500	ASME B16.5	F316/316L	Weld neck flange	Raised face
170	DN15	PN100/160	EN 1092-1	F316/F316L	Weld neck flange	Type B2
172	DN25	PN40	EN 1092-1	F316/F316L	Weld neck flange	Type B1
176	DN15	PN40	EN 1092-1	F316/F316L	Weld neck flange	Type B1
178	DN15	PN100	EN 1092-1	F316/F316L	Weld neck flange	Type D
183	DN25	PN40	EN 1092-1	F316/F316L	Weld neck flange	Type D
221	15mm	40K	JIS B 2220	F316/316L	Weld neck flange	Raised face
222	DN15		DIN11851	316/316L	Hygienic coupling	
310	DN15	PN40	EN 1092-1	F316/F316L	Weld neck flange	Type D
319	#8		VCO	316/316L	Swagelok compatible fitting	1/2-inch NPT female adapter
A94	1/2-inch	CL150	ASME B16.5	316/316L	Weld neck flange	Raised face 63-125 RA face finish
A95	1/2-inch	CL300	ASME B16.5	316/316L	Weld neck flange	Raised face 63-125 RA face finish
A96	1/2-inch	CL600	ASME B16.5	316/316L	Weld neck flange	Raised face 63-125 RA face finish
A97	1/2-inch	CL900/1500	ASME B16.5	316/316L	Weld neck flange	Raised face 63-125 RA face finish
A99	3/4-inch	CL150	ASME B16.5	316/316L	Weld neck flange	Raised face
B01	3/4-inch	CL300	ASME B16.5	316/316L	Weld neck flange	Raised face
B02	3/4-inch	CL600	ASME B16.5	316/316L	Weld neck flange	Raised face
B03	3/4-inch	CL900/1500	ASME B16.5	316/316L	Weld neck flange	Raised face
B04	1-inch	CL150	ASME B16.5	316/316L	Weld neck flange	Raised face
B05	1-inch	CL300	ASME B16.5	316/316L	Weld neck flange	Raised face
B06	1-inch	CL600	ASME B16.5	316/316L	Weld neck flange	Raised face
B07	1-inch	CL900/1500	ASME B16.5	316/316L	Weld neck flange	Raised face
B09	1/2-inch	CL300	ASME B16.5	316/316L	Weld neck flange	RJT face
B10	1/2-inch	CL600	ASME B16.5	316/316L	Weld neck flange	RJT face
B11	1/2-inch	CL900/1500	ASME B16.5	316/316L	Weld neck flange	RJT face
B77	#8	[blank]	VCR	316/316L	Swagelok compatible fitting	1/2-inch NPT female adapter
B78	#12	[blank]	VCR	316/316L	Swagelok compatible fitting	3/4-inch NPT female adapter
C73	DN15	PN40	EN 1092-1	316/316L	Weld neck flange	Type F

Model F025A

Code	Description					
113	1/2-inch	CL150	ASME B16.5	F316/F316L	Weld neck flange	Raised face
114	1/2-inch	CL300	ASME B16.5	F316/F316L	Weld neck flange	Raised face

Code	Description					
115	1/2-inch	CL600	ASME B16.5	F316/F316L	Weld neck flange	Raised face
122	15mm	20K	JIS B 2220	F316/F316L	Weld neck flange	Raised face
150	1/2-inch	CL900/ 1500	ASME B16.5	F316/F316L	Weld neck flange	Raised face
170	DN15	PN100/160	EN 1092-1	F316/F316L	Weld neck flange	Type B2
172	DN25	PN40	EN 1092-1	F316/F316L	Weld neck flange	Type B1
176	DN15	PN40	EN 1092-1	F316/F316L	Weld neck flange	Type B1
178	DN15	PN100	EN 1092-1	F316/F316L	Weld neck flange	Type D
183	DN25	PN40	EN 1092-1	F316/F316L	Weld neck flange	Type D
221	15mm	40K	JIS B 2220	F316/316L	Weld neck flange	Raised face
310	DN15	PN40	EN 1092-1	F316/F316L	Weld neck flange	Type D

Model F025P

Code	Description					
120	DN15	PN100/160	DIN 2638	F316/F316L	Weld neck flange	Form E face
150	1/2-inch	CL900/ 1500	ASME B16.5	F316/F316L	Weld neck flange	Raised face
170	DN15	PN100/160	EN 1092-1	F316/F316L	Weld neck flange	Type B2
178	DN15	PN100	EN 1092-1	F316/F316L	Weld neck flange	Type D
180	DN25	PN100	EN 1092-1	F316/F316L	Weld neck flange	Type B2
319	#8		VCO	316/316L	Swagelok compatible fitting	1/2-inch NPT female adapter

Models F025H and F025B

Code	Description					
517	1/2-inch	CL600	ASME B16.5	F304/F304L	Lap joint flange	N06022 stub
520	1/2-inch	CL150	ASME B16.5	F304/F304L	Lap joint flange	N06022 stub
521	1/2-inch	CL300	ASME B16.5	F304/F304L	Lap joint flange	N06022 stub
522	15mm	10K	JIS B 2220	F304/F304L	Lap joint flange	N06022 stub
524	DN15	PN40	EN 1092-1	F304/F304L	Lap joint flange	Type B1, N06022 stub

Model F050S

Code	Description					
113	1/2-inch	CL150	ASME B16.5	F316/F316L	Weld neck flange	Raised face
114	1/2-inch	CL300	ASME B16.5	F316/F316L	Weld neck flange	Raised face
115	1/2-inch	CL600	ASME B16.5	F316/F316L	Weld neck flange	Raised face
116	DN15	PN40	DIN 2635	F316/F316L	Weld neck flange	Form C face
120	DN15	PN100/160	DIN 2638	F316/F316L	Weld neck flange	Form E face
122	15mm	20K	JIS B 2220	F316/316L	Weld neck flange	Raised face

Code	Description					
131	DN25	PN40	DIN 2635	F316/F316L	Weld neck flange	Form C face
150	½-inch	CL900/1500	ASME B16.5	F316/F316L	Weld neck flange	Raised face
170	DN15	PN100/160	EN 1092-1	F316/F316L	Weld neck flange	Type B2
172	DN25	PN40	EN 1092-1	F316/F316L	Weld neck flange	Type B1
176	DN15	PN40	EN 1092-1	F316/F316L	Weld neck flange	Type B1
178	DN15	PN100	EN 1092-1	F316/F316L	Weld neck flange	Type D
183	DN25	PN40	EN 1092-1	F316/F316L	Weld neck flange	Type D
221	15mm	40K	JIS B 2220	F316/316L	Weld neck flange	Raised face
222	DN15		DIN11851	316/316L	Hygienic coupling	
239	#12		VCO	316/316L	Swagelok compatible fitting	3/4-inch NPT female adapter
310	DN15	PN40	EN 1092-1	F316/F316L	Weld neck flange	Type D
322	3/4-inch		Tri-Clamp compatible	316L	Hygienic fitting	
A94	1/2-inch	CL150	ASME B16.5	316/316L	Weld neck flange	Raised face 63-125 RA face finish
A95	1/2-inch	CL300	ASME B16.5	316/316L	Weld neck flange	Raised face 63-125 RA face finish
A96	1/2-inch	CL600	ASME B16.5	316/316L	Weld neck flange	Raised face 63-125 RA face finish
A97	1/2-inch	CL900	ASME B16.5	316/316L	Weld neck flange	Raised face 63-125 RA face finish
A99	3/4-inch	CL150	ASME B16.5	316/316L	Weld neck flange	Raised face
B01	3/4-inch	CL300	ASME B16.5	316/316L	Weld neck flange	Raised face
B02	3/4-inch	CL600	ASME B16.5	316/316L	Weld neck flange	Raised face
B03	3/4-inch	CL900/1500	ASME B16.5	316/316L	Weld neck flange	Raised face
B04	1-inch	CL150	ASME B16.5	316/316L	Weld neck flange	Raised face
B05	1-inch	CL300	ASME B16.5	316/316L	Weld neck flange	Raised face
B06	1-inch	CL600	ASME B16.5	316/316L	Weld neck flange	Raised face
B07	1-inch	CL900/1500	ASME B16.5	316/316L	Weld neck flange	Raised face
B09	1/2-inch	CL300	ASME B16.5	316/316L	Weld neck flange	RTJ face
B10	1/2-inch	CL600	ASME B16.5	316/316L	Weld neck flange	RTJ face
B11	1/2-inch	CL900/1500	ASME B16.5	316/316L	Weld neck flange	RTJ face
B77	#8	[blank]	VCR	316/316L	Swagelok compatible fitting	½-inch 316 NPT female adapter
B78	#12	[blank]	VCR	316/316L	Swagelok compatible fitting	3/4-inch 316 NPT female adapter
C73	DN15	PN40	EN 1092-1	316/316L	Weld neck flange	Type F

Model F050A

Code	Description					
113	1/2-inch	CL150	ASME B16.5	F316/F316L	Weld neck flange	Raised face
114	1/2-inch	CL300	ASME B16.5	F316/F316L	Weld neck flange	Raised face
115	1/2-inch	CL600	ASME B16.5	F316/F316L	Weld neck flange	Raised face
122	15mm	20K	JIS B 2220	F316/F316L	Weld neck flange	Raised face
150	1/2-inch	CL900/ 1500	ASME B16.5	F316/F316L	Weld neck flange	Raised face
170	DN15	PN100/160	EN 1092-1	F316/F316L	Weld neck flange	Type B2
172	DN25	PN40	EN 1092-1	F316/F316L	Weld neck flange	Type B1
176	DN15	PN40	EN 1092-1	F316/F316L	Weld neck flange	Type B1
178	DN15	PN100	EN 1092-1	F316/F316L	Weld neck flange	Type D
183	DN25	PN40	EN 1092-1	F316/F316L	Weld neck flange	Type D
221	15mm	40K	JIS B 2220	F316/316L	Weld neck flange	Raised face
310	DN15	PN40	EN 1092-1	F316/F316L	Weld neck flange	Type D

Model F050P

Code	Description					
113	1/2-inch	CL150	ASME B16.5	F316/F316L	Weld neck flange	Raised face
114	1/2-inch	CL300	ASME B16.5	F316/F316L	Weld neck flange	Raised face
115	1/2-inch	CL600	ASME B16.5	F316/F316L	Weld neck flange	Raised face
116	DN15	PN40	DIN 2635	F316/F316L	Weld neck flange	Form C face
120	DN15	PN100/160	DIN 2638	F316/F316L	Weld neck flange	Form E face
122	15mm	20K	JIS B 2220	F316/F316L	Weld neck flange	Raised face
131	DN25	PN40	DIN 2635	F316/F316L	Weld neck flange	Form C face
150	1/2-inch	CL900/ 1500	ASME B16.5	F316/F316L	Weld neck flange	Raised face
170	DN15	PN100/160	EN 1092-1	F316/F316L	Weld neck flange	Type B2
178	DN15	PN100	EN 1092-1	F316/F316L	Weld neck flange	Type D
180	DN25	PN100	EN 1092-1	F316/F316L	Weld neck flange	Type B2
222	DN15		DIN11851	316/316L	Hygienic coupling	
239	#12		VCO	316/316L	Swagelok compatible fitting	3/4-inch NPT female adapter
322	3/4-inch		Tri-Clamp compatible	316L	Hygienic fitting	

Models F050H and F050B

Code	Description					
517	1/2-inch	CL600	ASME B16.5	F304/F304L	Lap joint flange	N06022 stub
520	1/2-inch	CL150	ASME B16.5	F304/F304L	Lap joint flange	N06022 stub

Code	Description					
521	1/2-inch	CL300	ASME B16.5	F304/F304L	Lap joint flange	N06022 stub
522	15mm	10K	JIS B 2220	F304/F304L	Lap joint flange	N06022 stub
524	DN15	PN40	EN 1092-1	F304/F304L	Lap joint flange	Type B1, N06022 stub

Model F100S

Code	Description					
128	1-inch	CL150	ASME B16.5	F316/F316L	Weld neck flange	Raised face
129	1-inch	CL300	ASME B16.5	F316/F316L	Weld neck flange	Raised face
130	1-inch	CL600	ASME B16.5	F316/F316L	Weld neck flange	Raised face
131	DN25	PN40	DIN 2635	F316/F316L	Weld neck flange	Form C face
137	DN25	PN100/160	DIN 2638	F316/F316L	Weld neck flange	Form E face
138	1-inch		Tri-Clamp compatible	316L	Hygienic fitting	
139	25mm	20K	JIS B 2220	F316/F316L	Weld neck flange	Raised face
179	DN25	PN40	EN 1092-1	F316/F316L	Weld neck flange	Type B1
180	DN25	PN100	EN 1092-1	F316/F316L	Weld neck flange	Type B2
181	DN25	PN100	EN 1092-1	F316/F316L	Weld neck flange	Type D
209	2-inch	CL150	ASME B16.5	F316/F316L	Weld neck flange	Raised face
229	25mm	40K	JIS B 2220	F316/316L	Weld neck flange	Raised face
230	DN25		DIN11851	316/316L	Hygienic coupling	
311	DN25	PN40	EN 1092-1	F316/F316L	Weld neck flange	Type D
928	1-inch	CL900/1500	ASME B16.5	F316/F316L	Weld neck flange	Raised face
B14	1-inch	CL150	ASME B16.5	F316/F316L	Weld neck flange	Raised face 63-125 Ra face finish
B15	1-inch	CL300	ASME B16.5	F316/F316L	Weld neck flange	Raised face 63-125 Ra face finish
B16	1-inch	CL600	ASME B16.5	F316/F316L	Weld neck flange	Raised face 63-125 Ra face finish
B17	1 1/2-inch	CL150	ASME B16.5	F316/F316L	Weld neck flange	Raised face
B18	1 1/2-inch	CL300	ASME B16.5	F316/F316L	Weld neck flange	Raised face
B19	1 1/2-inch	CL600	ASME B16.5	F316/F316L	Weld neck flange	Raised face
B20	1 1/2-inch	CL900/1500	ASME B16.5	F316/F316L	Weld neck flange	Raised face
B21	2-inch	CL300	ASME B16.5	F316/F316L	Weld neck flange	Raised face
B22	2-inch	CL600	ASME B16.5	F316/F316L	Weld neck flange	Raised face
B23	2-inch	CL900/1500	ASME B16.5	F316/F316L	Weld neck flange	Raised face

Code	Description					
B24	1-inch	CL300	ASME B16.5	F316/F316L	Weld neck flange	RTJ face
B25	1-inch	CL600	ASME B16.5	F316/F316L	Weld neck flange	RTJ face
B26	1 1/2-inch	CL900/1500	ASME B16.5	F316/F316L	Weld neck flange	RTJ face
B81	#16	[blank]	VCO	F316/F316L	Swagelok compatible fitting	1-inch 316 NPT female adapter
B82	#16	[blank]	VCR	F316/F316L	Swagelok compatible fitting	1-inch 316 NPT female adapter
C74	DN25	PN40	EN 1092-1	F316/F316L	Weld neck flange	Type F

Model F100A

Code	Description					
128	1-inch	CL150	ASME B16.5	F316/F316L	Weld neck flange	Raised face
129	1-inch	CL300	ASME B16.5	F316/F316L	Weld neck flange	Raised face
130	1-inch	CL600	ASME B16.5	F316/F316L	Weld neck flange	Raised face
139	25mm	20K	JIS B 2220	F316/F316L	Weld neck flange	Raised face
179	DN25	PN40	EN 1092-1	F316/F316L	Weld neck flange	Type B1
209	2-inch	CL150	ASME B16.5	F316/F316L	Weld neck flange	Raised face
229	25mm	40K	JIS B 2220	F316/316L	Weld neck flange	Raised face
311	DN25	PN40	EN 1092-1	F316/F316L	Weld neck flange	Type D
928	1-inch	CL900	ASME B16.5	F316/F316L	Weld neck flange	Raised face

Models F100H and F100B

Code	Description					
530	1-inch	CL150	ASME B16.5	F304/F304L	Lap joint flange	N06022 stub
531	1-inch	CL300	ASME B16.5	F304/F304L	Lap joint flange	N06022 stub
532	25mm	10K	JIS B 2220	F304/F304L	Lap joint flange	N06022 stub
534	DN25	PN40	EN 1092-1	F304/F304L	Lap joint flange	Type B1, N06022 stub
535	1-inch	CL600	ASME B16.5	F304/F304L	Lap joint flange	N06022 stub

Model F100P

Code	Description					
C55	1-inch	CL2500	ASME B16.5	Nickel alloy C22	Weld neck flange	RTJ
C56	1-1/2-inch	CL2500	ASME B16.5	Nickel alloy C22	Weld neck flange	RTJ
C57	1-inch	CL2500 (360 bar)	ASME B16.5	F316/F316L	Weld neck flange	RTJ

Code	Description					
C58	1-1/2-inch	CL2500(360 bar)	ASME B16.5	F316/F316L	Weld neck flange	RTJ
C64	1-inch	CL2500	ASME B16.5	F316/F316L	Weld neck flange	RTJ
C65	1-1/2-inch	CL2500	ASME B16.5	F316/F316L	Weld neck flange	RTJ

Model F200S

Code	Description					
312	DN40	PN40	EN 1092-1	F316/F316L	Weld neck flange	Type D
316	DN50	PN40	EN 1092-1	F316/F316L	Weld neck flange	Type D
341	1-1/2-inch	CL150	ASME B16.5	F316/F316L	Weld neck flange	Raised face
342	1-1/2-inch	CL300	ASME B16.5	F316/F316L	Weld neck flange	Raised face
343	1-1/2-inch	CL600	ASME B16.5	F316/F316L	Weld neck flange	Raised face
351	1-1/2-inch		Tri-Clamp compatible	316L	Hygienic fitting	
352	2-inch		Tri-Clamp compatible	316L	Hygienic fitting	
353	DN40		DIN11851	316/316L	Hygienic coupling	
363	DN40	PN100	EN 1092-1	F316/F316L	Weld neck flange	Type B2
365	DN50	PN100	EN 1092-1	F316/F316L	Weld neck flange	Type B2
366	DN40	PN100	EN 1092-1	F316/F316L	Weld neck flange	Type D
367	DN50	PN100	EN 1092-1	F316/F316L	Weld neck flange	Type D
368	DN40	PN40	EN 1092-1	F316/F316L	Weld neck flange	Type B1
369	DN50	PN40	EN 1092-1	F316/F316L	Weld neck flange	Type B1
378	DN50	PN100	DIN 2637	F316/F316L	Weld neck flange	Form E face
381	DN40	PN40	DIN 2635	F316/F316L	Weld neck flange	Form C face
382	DN50	PN40	DIN 2635	F316/F316L	Weld neck flange	Form C face
385	40mm	10K	JIS B 2220	F316/F316L	Weld neck flange	Raised face
386	50mm	10K	JIS B 2220	F316/316L	Weld neck flange	Raised face
387	40mm	20K	JIS B 2220	F316/F316L	Weld neck flange	Raised face
388	50mm	20K	JIS B 2220	F316/316L	Weld neck flange	Raised face
418	2-inch	CL150	ASME B16.5	F316/F316L	Weld neck flange	Raised face
419	2-inch	CL300	ASME B16.5	F316/F316L	Weld neck flange	Raised face
420	2-inch	CL600	ASME B16.5	F316/F316L	Weld neck flange	Raised face

Code	Description					
A31	1 1/2-inch	CL900/1500	ASME B16.5	F316/F316L	Weld neck flange	Raised face
A32	1 1/2-inch	CL150	ASME B16.5	F316/F316L	Weld neck flange	Raised face 63-125 Ra face finish
A33	1 1/2-inch	CL300	ASME B16.5	F316/F316L	Weld neck flange	Raised face 63-125 Ra face finish
A34	1 1/2-inch	CL600	ASME B16.5	F316/F316L	Weld neck flange	Raised face 63-125 Ra face finish
A35	2-inch	CL900/1500	ASME B16.5	F316/F316L	Weld neck flange	Raised face
A36	3-inch	CL150	ASME B16.5	F316/F316L	Weld neck flange	Raised face
A37	3-inch	CL300	ASME B16.5	F316/F316L	Weld neck flange	Raised face
A38	3-inch	CL600	ASME B16.5	F316/F316L	Weld neck flange	Raised face
A39	2-inch	CL150	ASME B16.5	F316/F316L	Weld neck flange	Raised face 63-125 Ra face finish
A40	2-inch	CL300	ASME B16.5	F316/F316L	Weld neck flange	Raised face 63-125 Ra face finish
A41	2-inch	CL600	ASME B16.5	F316/F316L	Weld neck flange	Raised face 63-125 Ra face finish
A42	2-inch	CL150	ASME B16.5	F316/F316L	Weld neck flange	RTJ face
A43	2-inch	CL300	ASME B16.5	F316/F316L	Weld neck flange	RTJ face
A44	2-inch	CL600	ASME B16.5	F316/F316L	Weld neck flange	RTJ face
A45	2-inch	CL900/1500	ASME B16.5	F316/F316L	Weld neck flange	RTJ face
B55	2-inch	CL600	ASME B16.5	A105 Carbon Steel	Lap joint flange	316/316L stub
B85	50mm	10K	JIS B 2220	A105 Carbon Steel	Lap joint flange	316/316L stub
B86	50mm	20K	JIS B 2220	A105 Carbon Steel	Lap joint flange	316/316L stub
C75	DN40	PN40	EN 1092-1	F316/F316L	Weld neck flange	Type F
C76	DN50	PN40	EN 1092-1	F316/F316L	Weld neck flange	Type F

Model F200H

Code	Description					
537	1-1/2-inch	CL600	ASME B16.5	F304/F304L	Lap joint flange	N06022 stub
540	1-1/2-inch	CL150	ASME B16.5	F304/F304L	Lap joint flange	N06022 stub
541	1-1/2-inch	CL300	ASME B16.5	F304/F304L	Lap joint flange	N06022 stub
542	40mm	10K	JIS 2220	F304/F304L	Lap joint flange	N06022 stub

Code	Description					
544	2-inch	CL150	ASME B16.5	F304/F304L	Lap joint flange	N06022 stub
545	2-inch	CL300	ASME B16.5	F304/F304L	Lap joint flange	N06022 stub
546	50mm	10K	JIS B 2220	F304/F304L	Lap joint flange	N06022 stub
548	DN40	PN40	EN 1092-1	F304/F304L	Lap joint flange	Type B1, N06022 stub
549	DN50	PN40	EN 1092-1	F304/F304L	Lap joint flange	Type B1, N06022 stub

Model F300S

Code	Description					
326	DN80	PN40	EN 1092-1	F316/F316L	Weld neck flange	Type D
333	DN100	PN40	EN 1092-1	F316/F316L	Weld neck flange	Type D
355	3-inch	CL150	ASME B16.5	F316/F316L	Weld neck flange	Raised face
356	3-inch	CL300	ASME B16.5	F316/F316L	Weld neck flange	Raised face
357	3-inch	CL600	ASME B16.5	F316/F316L	Weld neck flange	Raised face
358	3-inch	CL900	ASME B16.5	F316/F316L	Weld neck flange	Raised face
359	DN100	PN100	EN 1092-1	F316/F316L	Weld neck flange	Type D
361	3-inch		Tri-Clamp compatible	316L	Hygienic fitting	
371	DN80	PN40	EN 1092-1	F316/F316L	Weld neck flange	Type B1
372	DN100	PN40	EN 1092-1	F316/F316L	Weld neck flange	Type B1
373	DN80	PN100	EN 1092-1	F316/F316L	Weld neck flange	Type B2
374	DN100	PN100	EN 1092-1	F316/F316L	Weld neck flange	Type B2
375	DN80	PN100	EN 1092-1	F316/F316L	Weld neck flange	Type D
391	DN80	PN40	DIN 2635	F316/F316L	Weld neck flange	Form C face
392	DN100	PN40	DIN 2635	F316/F316L	Weld neck flange	Form C face
393	DN80	PN40	DIN 2635	F316/F316L	Weld neck flange	Form N grooved face
394	DN100	PN40	DIN 2635	F316/F316L	Weld neck flange	Form N grooved face
395	DN80	PN100	DIN 2637	F316/F316L	Weld neck flange	Form E face
396	DN100	PN100	DIN 2637	F316/F316L	Weld neck flange	Form E face
397	DN80	PN100	DIN 2637	F316/F316L	Weld neck flange	Form N grooved face
398	DN100	PN100	DIN 2637	F316/F316L	Weld neck flange	Form N grooved face
400	80mm	10K	JIS B 2220	F316/F316L	Weld neck flange	Raised face
401	100mm	10K	JIS B 2220	F316/F316L	Weld neck flange	Raised face
402	80mm	20K	JIS B 2220	F316/F316L	Weld neck flange	Raised face
410	3-inch		Grooved coupling	316L	Hygienic coupling	
425	4-inch	CL150	ASME B16.5	F316/F316L	Weld neck flange	Raised face
426	4-inch	CL300	ASME B16.5	F316/F316L	Weld neck flange	Raised face

Code	Description					
427	4-inch	CL600	ASME B16.5	F316/F316L	Weld neck flange	Raised face
428	4-inch	CL900	ASME B16.5	F316/F316L	Weld neck flange	Raised face
A47	3-inch	CL150	ASME B16.5	F316/F316L	Weld neck flange	Raised face 63-125 Ra face finish
A48	3-inch	CL300	ASME B16.5	F316/F316L	Weld neck flange	Raised face 63-125 Ra face finish
A49	3-inch	CL600	ASME B16.5	F316/F316L	Weld neck flange	Raised face 63-125 Ra face finish
A50	3-inch	CL900	ASME B16.5	F316/F316L	Weld neck flange	Raised face 63-125 Ra face finish
A52	4-inch	CL600	ASME B16.5	F316/F316L	Weld neck flange	Raised face 63-125 Ra face finish
A53	4-inch	CL900	ASME B16.5	F316/F316L	Weld neck flange	Raised face 63-125 Ra face finish
A54	3-inch	CL150	ASME B16.5	F316/F316L	Weld neck flange	RTJ face
A55	3-inch	CL300	ASME B16.5	F316/F316L	Weld neck flange	RTJ face
A56	3-inch	CL600	ASME B16.5	F316/F316L	Weld neck flange	RTJ face
A57	3-inch	CL900	ASME B16.5	F316/F316L	Weld neck flange	RTJ face
A58	4-inch	CL150	ASME B16.5	F316/F316L	Weld neck flange	RTJ face
A59	4-inch	CL300	ASME B16.5	F316/F316L	Weld neck flange	RTJ face
A60	4-inch	CL600	ASME B16.5	F316/F316L	Weld neck flange	RTJ face
A61	4-inch	CL900	ASME B16.5	F316/F316L	Weld neck flange	RTJ face
B59	3-inch	CL300	ASME B16.5	A105 Carbon Steel	Lap joint flange	316/316L stub
B60	3-inch	CL600	ASME B16.5	A105 Carbon Steel	Lap joint flange	316/316L stub
B87	100mm	10K	JIS B 2220	A105 Carbon Steel	Lap joint flange	316/316L stub
B88	100mm	20K	JIS B 2220	A105 Carbon Steel	Lap joint flange	316/316L stub
C77	DN80	PN40	EN 1092-1	F316/F316L	Weld neck flange	Type F

Model F300H

Code	Description					
550	3-inch	CL150	ASME B16.5	F304/F304L	Lap joint flange	N06022 stub
551	3-inch	CL300	ASME B16.5	F304/F304L	Lap joint flange	N06022 stub
552	80mm	10K	JIS B 2220	F304/F304L	Lap joint flange	N06022 stub
554	DN80	PN40	EN 1092-1	F304/F304L	Lap joint flange	Type B1, N06022 stub
539	3-inch	CL600	ASME B16.5	F304/F304L	Lap joint flange	N06022 stub

Case options

Case options for Models F025 – F200 (except Model F100P)

Code	Case option
C	Compact case
P	Compact case with purge fittings (1/2-inch NPT female)
D	Compact case with rupture disk (1/2-inch NPT male)

Case options for Model F100P only

Code	Case option
K	Compact 316L case with rupture disk (1 inch NPT male fitting)

Case options for Model F300 only

Code	Case option
D	Enhanced case with rupture disk (1/2-inch NPT male)
E	Enhanced case
P	Enhanced case with purge fittings (1/2-inch NPT female)
F	3-inch Compact case retrofit installation (face-to-face extension mount)

Electronics interface

Code descriptions

Code	Description
0	For integral mount Model 2400S transmitter
1	For extended mount Model 2400S transmitter
2	4-wire polyurethane-painted aluminum integral enhanced core processor for remote mount transmitters
3	4-wire stainless steel integral enhanced core processor for remote mount transmitters
4	4-wire polyurethane-painted aluminum integral extended mount enhanced core processor for remote mount transmitters
5	4-wire extended mount stainless steel integral enhanced core processor for remote mount transmitters
6 ⁽¹⁾	MVDSolo; polyurethane-painted aluminum integral enhanced core processor (for OEMs)
7 ⁽¹⁾	MVDSolo; stainless steel integral enhanced core processor (for OEMs)
8 ⁽¹⁾	MVDSolo; extended mount polyurethane-painted aluminum integral enhanced core processor (for OEMs)
9 ⁽¹⁾	MVDSolo; extended mount stainless steel enhanced core processor (for OEMs)
Q	4-wire polyurethane-painted aluminum integral core processor for remotely mounted transmitter with MVD technology
A	4-wire stainless steel integral core processor for remotely mounted transmitter with MVD technology
C	For integrally mounted Model 1700 or 2700 transmitter

Code	Description
L ⁽²⁾	For integrally mounted standard-finish FMT transmitter
K ⁽²⁾	Integrally mounted improved-surface finish (64 Ra) FMT transmitter
W ⁽¹⁾	MVDSolo; polyurethane-painted aluminum integral core processor for direct host connection (for OEMs)
D ⁽¹⁾	MVDSolo; stainless steel integral core processor for direct host connection (for OEMs)
R	9-wire polyurethane-painted aluminum junction box
H	9-wire polyurethane-painted aluminum junction box with extended mount
S	9-wire stainless steel junction box
T	9-wire stainless steel junction box with extended mount
J	For integrally mounted Model 2200S transmitter; only available with calibration option Z
U	Extended Model 2200S transmitter; only available with calibration option Z
F	For integral mount Model 5700 transmitter

(1) When electronics interface W, D, 6, 7, 8 or 9 is ordered with approval C, A, I, Z, P, or G (with Country Specific approval R1 or B1), MVD Direct Connect™ I.S. barrier is supplied.

(2) Must be ordered with transmitter; only available with case code C; on F025S, only available with process connection 319, 121, or 222.

Codes available by model

Model	Available codes																											
	F	U	J	T	S	H	R	E	Y	D	W	K	L	C	B	V	A	Q	9	8	7	6	5	4	3	2	1	0
F025S-F100S	F	U	J	T	S	H	R			D	W	K	L	C			A	Q	9	8	7	6	5	4	3	2	1	0
F100P	F																		9	8	7	6	5	4	3	2		
F200S-F300S; F025H-F300H; F025P-F050P	F	U	J	T	S	H	R			D	W			C			A	Q	9	8	7	6	5	4	3	2	1	0
F025A-F100A; F025B-F100B				T	S	H	R																					

Conduit connections

Code descriptions

Code	Description
A	3/4-inch NPT — no gland
B ⁽¹⁾	1/2-inch NPT — no gland
E	M20 — no gland; not available with electronics interface code Q, A, V, or B in combination with approval code T or S on models F200S-F300S
F ⁽¹⁾	Brass/nickel cable gland (cable diameter 0.335 to 0.394 inches [8.5 to 10 mm])
G ⁽¹⁾	Stainless steel cable gland (cable diameter 0.335 to 0.394 inches [8.5 to 10 mm])
H ⁽¹⁾	Brass/nickel cable gland
J ⁽¹⁾	Stainless steel cable gland

Code	Description
K ⁽²⁾	JIS B0202 1/2G - no gland
L ⁽²⁾	Japan - brass nickel gland
M ⁽²⁾	Japan - stainless cable gland
N ⁽²⁾	JIS B0202 3/4G - no gland
O ⁽²⁾	Japan - brass nickel gland
p ⁽²⁾	Japan - stainless cable gland

(1) Not available with approval code T, S, or J on models F200-F300.

(2) Only available with approval code M, T, or S.

Codes available by model

Model	Available codes													
	P	O	N	M	L	K	J	H	G	F	E	B	A	
All models with electronics interface codes 0, 1, C, J, U, K, L, and F														A
All models with electronics interface codes 2, 3, 4, 5, Q, A, V, and B				M	L	K			G	F	E	B		
All models with electronics interface code T							J	H						A
All models with electronics interface codes 6, 7, 8, 9, W, D, Y, and E									G	F	E	B		
F025S-F300S; F025H-F300H with electronics interface codes R, H, and S	P	O	N				J	H						A
F025A-F100A; F025B-F100B with electronics interface codes R and S									G	F	E	B		
F100P				M	L	K			G	F	E	B		

Approvals

Code descriptions

Read the approval code descriptions carefully to identify additional restrictions.

Code	Description
A	CSA (US and Canada): Class 1, Division 1, Groups C and D
C	CSA (Canada only); only available with material codes S and P (not available with material codes A, B, or H)
G	Country Specific Approval – Requires a selection from the Approvals section of the ‘Certificate, Tests, Calibrations and Services’ model code option
I	IECEX Zone 1
J	Hardware ready for TIIS approval; requires conduit connection code E when used with electronics interface code 2, 3, 4, 5, Q, A, V, or B
M	Micro Motion Standard (no approval)
N	Micro Motion Standard / PED compliant

Code	Description
P	NEPSI; only available with language option M (Chinese)
S	TIIS – T3 Temperature Classification; not available for quote outside of Japan
T	TIIS - T4 Temperature Classification; not available for quote outside of Japan
U	UL; only available with models F025S-F200S
V	ATEX - Equipment Category 3 (Zone 2) / PED compliant
Z	ATEX - Equipment Category 2 (Zone 1) / PED compliant
2	CSA (US and Canada): Class 1, Division 2, Groups A,B,C,D
3	IECEX Zone 2

Codes available by model

Model ⁽¹⁾	With electronics interface code	Available codes														
		3	2	Z	V	U	T	S	P	N	M	J	I	G	C	A
All (except F100P)	0, 1, L, and K	3	2		V					N	M			G		
	Q, A, V, and B			Z			T	S	P	N	M	J	I	G	C	A
	6, 7, 8, 9			Z					P	N	M		I	G	C	A
	C	3	2	Z			T	S	P	N	M	J	I	G	C	A
	T			Z						N	M		I		C	A
	W, D, Y, and E			Z					P	N	M		I	G	C	A
	F	3	2	Z	V		T	S		N	M		I	G		A
F025H-F300H; F025S-F300S; F025P-F050P	R, H, and S			Z		U	T	S	P	N	M	J	I	G	C	A
F025H-F300H; F025S-F300S	2, 3, 4, 5			Z			T	S	P	N	M	J	I	G		A
	J and U	3		Z	V		T	S		N	M	J	I	G	C	A
F025A-F100A; F025B-F100B	R and S			Z					P	N	M		I	G		A
F025P-F050P	2, 3, 4, 5			Z					P	N	M		I	G		A
	J and U	3		Z	V					N	M		I	G	C	A
F100P	2, 3, 4, 5			Z						N	M		I			A
	6, 7, 8, 9			Z						N	M		I			A
	J and U	3		Z	V					N	M		I			A
	F	3	2	Z	V		T	S		N	M		I	G		A

(1) Read the approval code descriptions carefully to identify additional restrictions.

Languages

Code	Language option
A	Danish CE requirements document and English installation manual

Code	Language option
C	Czech installation manual
D	Dutch CE requirements document and English installation manual
E	English installation manual
F	French installation manual
G	German installation manual
H	Finnish CE requirements document and English installation manual
I	Italian installation manual
J	Japanese installation manual
M	Chinese installation manual
N	Norwegian CE requirements document and English installation manual
O	Polish installation manual
P	Portuguese installation manual
S	Spanish installation manual
W	Swedish CE requirements document and English installation manual
B	Hungarian CE requirements document and English installation manual
K	Slovak CE requirements document and English installation manual
T	Estonian CE requirements document and English installation manual
U	Greek CE requirements document and English installation manual
L	Latvian CE requirements document and English installation manual
V	Lithuanian CE requirements document and English installation manual
Y	Slovenian CE requirements document and English installation manual

Additional standard approvals

Code	Additional standard approvals
Z	No additional standard approval options selected; does not apply to Model F100P
Z	Rated to 5220 psi (360 bar) – no additional standard approval options selected; only applies to Model F100P
N	Rated to 5220 psi (360 bar) – all nickel alloy C22 components comply with NORSOK M-650 where applicable
H	Rated up to 6250 psi (431 bar) – no additional standard approval options selected
K	Rated up to 6250 psi (431 bar) – all nickel alloy C22 components comply with NORSOK M-650 where applicable

Calibration

Code	Calibration option
Z	0.20% mass flow and 0.002 g/cm ³ (2.0 kg/m ³) density calibration
A ⁽¹⁾	0.15% mass flow and 0.002 g/cm ³ (2.0 kg/m ³) density calibration

Code	Calibration option
1 ⁽¹⁾	0.10% mass flow and 0.001 g/cm ³ (1.0 kg/m ³) density calibration
K ⁽²⁾	0.10% mass flow and 0.0005 g/cm ³ (0.5 kg/m ³) density calibration
C	0.10% mass flow and 0.002 g/cm ³ (2.0 kg/m ³) density calibration; only available with Model F100P

(1) Not available with Model F100P; not available with electronics interface code J or U.

(2) Only available with electronics code 0, 1, 2, 3, 4, 5, 6, 7, 8, and 9; not available with Model F025 or any high temperature or high pressure models (base material/application code A, B, or P).

Measurement application software (all models)

Code	Measurement application software option
Z	No measurement application software

Factory options

Code	Factory option
Z	Standard product
X	ETO product
R	Restocked product (if available)

Certificates, tests, calibrations, and services

These option codes can be added to the end of the model code if needed, but no code is required when none of these options is selected.

Note

There may be additional options or limitations depending on total meter configuration. Contact a sales representative before making your final selections.

Material quality examination tests and certificates

Select any from this group.

Code	Factory option
MC	Material inspection certificate 3.1 (supplier lot traceability per EN 10204)
NC	NACE certificate 2.1 (MR0175 and MR0103)
KH	<p>KHK package 3.1 — certificate package to accommodate approval in Japan. Includes:</p> <ul style="list-style-type: none"> ■ Radiographic and tube wall examination ■ HSB witness primary containment hydrostatic and pneumatic testing ■ Material inspection certificate <p>Not available with codes RI, RC, HT, MC (because they are already included); not available with nickel alloy C22 models (F025H–F300H or F025B–F100B)</p>

Radiographic testing

Select only one from this group.

Code	Factory option
RE	X-ray package 3.1 (radiographic examination certificate; weld map; radiographic inspection NDE qualification)
RT	X-Ray package 3.1 (radiographic examination certificate with digital image; weld map; radiographic inspection NDE qualification)

Pressure testing

Code	Factory option
HT	Hydrostatic test certificate 3.1 (wetted components only)

Dye penetrant examination

Select any from this group.

Code	Factory option
D1	Dye penetrant test package 3.1 (Liquid Dye Penetration NDE Qualification): <ul style="list-style-type: none"> ■ Process connection only for F300 sensors ■ Sensor only for all other sensor models

Weld examination

Code	Factory option
WP	Weld procedure package (weld map, weld procedure specification, weld procedure qualification record, welder performance qualification)

Positive material testing

Select only one from this group.

Code	Factory option
PM	Positive material test certificate 3.1 (without carbon content)
PC	Positive material test certificate 3.1 (including carbon content); not available with nickel alloy C22 models (F025H–F300H or F025B–F100B)

ASME B31.1 Power Piping design code certification

Code	Factory option
GC	B31.1 Power Piping design code certification; not available with Model F100P

Special cleaning

Code	Factory option
O2	Declaration of compliance oxygen service 2.1

GOST compliance

Code	Factory option
GR	Russian GOST calibration verification certificate

Accredited Calibration

Select only one from this group.

Code	Factory option
IC	ISO17025 accredited calibration and certificates (9 points total)

Special calibration options

Select either none, CV, or CV with one of the additional verification point options.

Note

Minimum flow rates may apply when selecting the special calibration option.

Code	Factory option
CV	Custom verification (alter original verification points)
01	Add 1 additional verification point
02	Add 2 additional verification point
03	Add 3 additional verification point
06	Add up to 6 additional verification points
08	Add up to 8 additional verification points
16	Add up to 16 additional verification points

Weights and measures

Code	Factory option
WM	Tag for US NTEP certified applications; not available on Model F100P or any F025 or F300 models
WC	Tag for Measurements Canada certified applications; not available with Approval code P

Sensor completion

Select any from this group.

Code	Factory option
WG	Witness general
SP	Special packaging

Country specific approvals

Select one from the following if approval code G is selected.

Code	Factory option
R1	EAC Zone 1 – Hazardous Approval ⁽¹⁾⁽²⁾
R3	EAC Zone 2 – Hazardous Approval ⁽¹⁾⁽³⁾

Code	Factory option
B1	INMETRO Zone 1 – Hazardous Approval ⁽¹⁾⁽²⁾
B3	INMETRO Zone 2 – Hazardous Approval ⁽¹⁾⁽³⁾

(1) Only available with approval code G. Not available on Model F100P.

(2) Not available with electronics code 0 or 1.

(3) Only available with electronics code 0, 1, J, U, K, and L.